

# ASSEMBLY AND INSTALLATION INSTRUCTIONS

C0253

**WARNING:** TO AVOID RISK OF ELECTRICAL SHOCK, BE SURE TO SHUT OFF POWER BEFORE INSTALLING OR SERVICING THIS FIXTURE.

**NOTES:** 1. Before installing, consult local electrical codes for wiring and grounding requirements.  
2. READ AND SAVE THESE INSTRUCTIONS.

## Hardware Package (included):

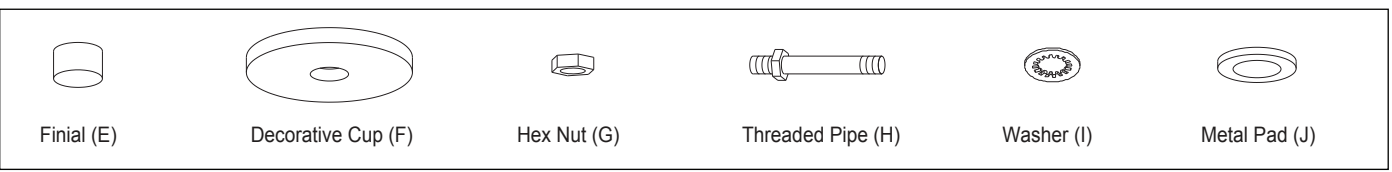
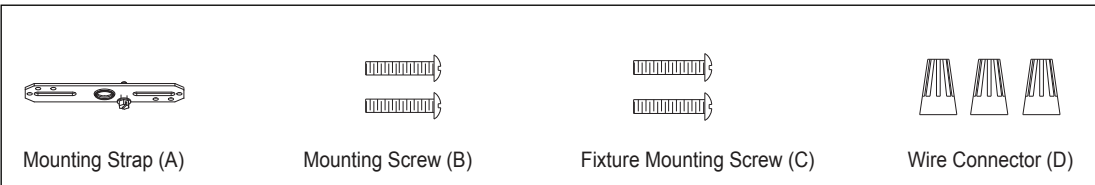

## Installation Steps

Turn off the power at fuse or circuit box

1. Attach the two fixture mounting screws (C) to the holes on the mounting strap (A), and screw them in 2 to 3 turns.
2. Attach the mounting strap (A) to the outlet box using two mounting screws (B).
3. Pull out the source wires from the outlet box. Make wire connections using wire connectors (D) as follows:
  - Connect the hot wire (black insulation) from the fixture to the black wire from the power source.
  - Connect the neutral wire (white insulation) from the fixture to the white wire from the power source.
  - Attach the fixture ground wire (bare wire) to the mounting strap (A) with the green ground screw, and then connect it to the house ground wire with the wire connector (D).Carefully put the wires back into the outlet box.
4. Attach the ceiling pan to the mounting strap (A) by inserting two fixture mounting screws (C) head into the keyholes, and rotate the pan until it locks in place. Then secure the screws tightly.
5. Screw the threaded pipe (H) into the coupling, then secure it with a washer (I) and hex nut (G).  
**Note: Depth of threaded pipe may need to be adjusted to properly fit glass shade, decorative cup, and finial.**
6. Install 2 x 60W max medium base bulbs (not included) to the sockets.

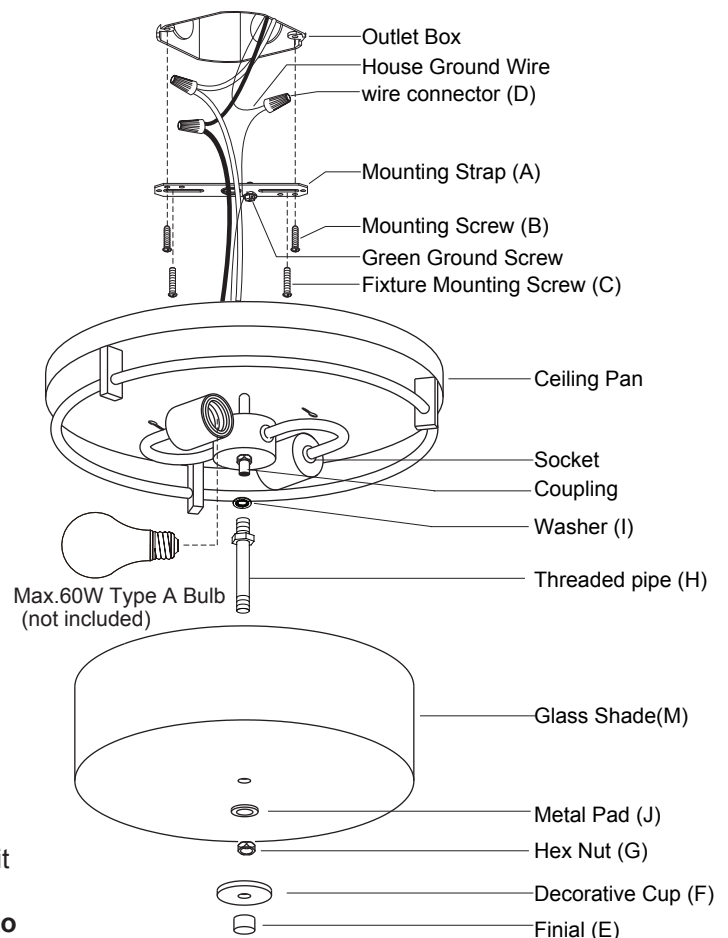

7. Slip the glass shade through the threaded pipe (H) and upward the ceiling pan. Then tighten them with the metal pad (J) and hex nut (G) .

**Caution: Do not over tighten, breakage of glass shade could be occurred.**

8. Slip the decorative cup (F) up through the threaded pipe (H), secure it with a finial (E).

Turn on the power at fuse or circuit box

The following parts are available for re-order if damaged or missing.

**Spare Parts List:**



Mounting Strap (A)



Mounting Screw (B)



Fixture Mounting Screw (C)

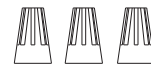

Wire Connector (D)



Finial (E)

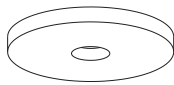

Decorative Cup (F)



Hex Nut (G)

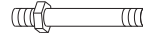

Threaded Pipe (H)



Washer (I)



Metal Pad (J)

Assembly Kit  
6340MM (1 SET)

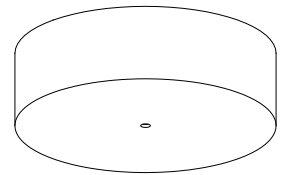

Glass Shade  
9917CS

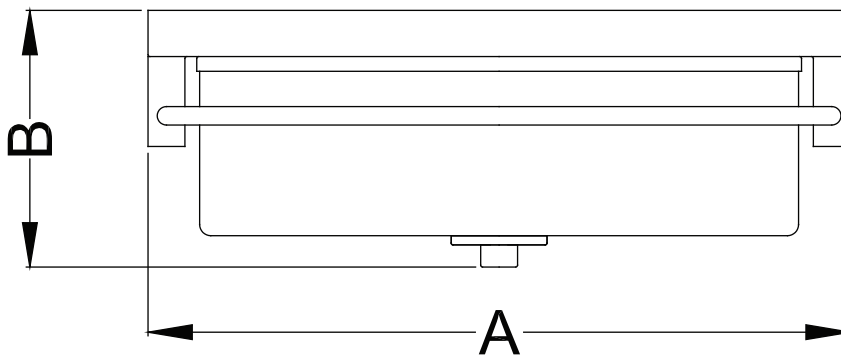

**A: 15"**  
**B: 5-1/2"**