

The 12V EmeryAllen MR16 retrofit lamp is an energy efficient alternative to 12V halogen MR16 lamps. It offers similar light output to a 12V, 50W incandescent (450-550lm) and is suitable for use in most 12V GU5.3 MR16 fixtures.

Base Type	GU5.3
Material	Ceramic + PC
Input Voltage	12V AC
Wattage	7.0
Volt-Amperes (VA)	7.320W
CRI	90+
Lumens	509 lumens
Lumens/Watt	79
CBCP	870
Color Temperature	2700K & 3000K
R9	55
R13	96
Halogen Equivalent	50W

Available Models:

- EA-MR16-7.0W-36D-2790-D (2700K)
- EA-MR16-7.0W-36D-3090-D (3000K)

Dimming:

- Dimmable with most magnetic and electronic LED compatible transformers. AC current only.
- Dimmable with most MLV and ELV dimmers.

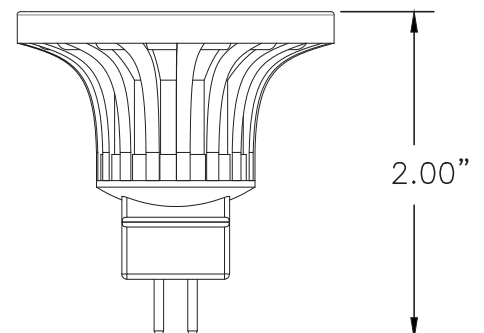
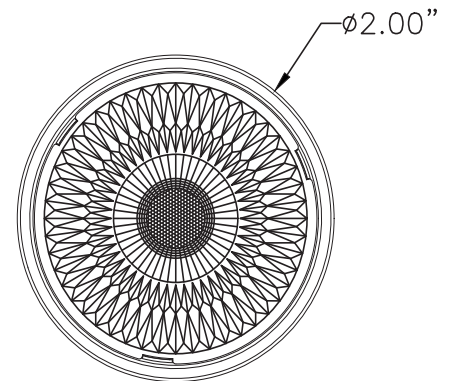



EmeryAllen GU5.3 MR16 7.0W - 36°

CANDELA DISTRIBUTION

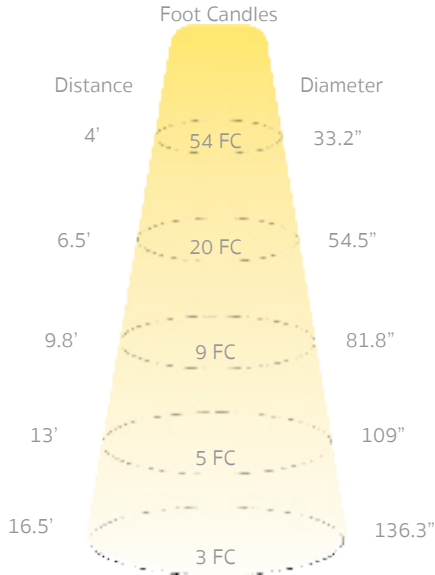

LUMINOUS INTENSITY

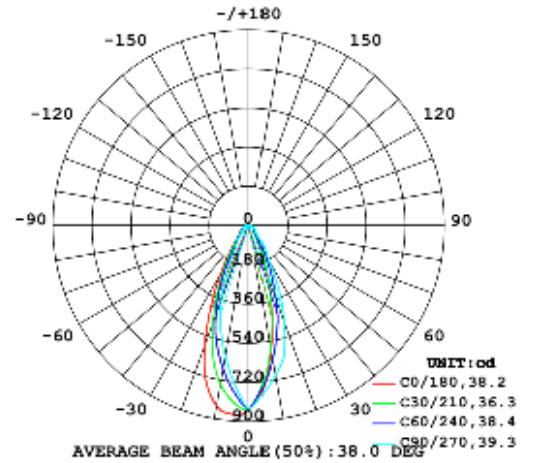

SPECTRAL DISTRIBUTION

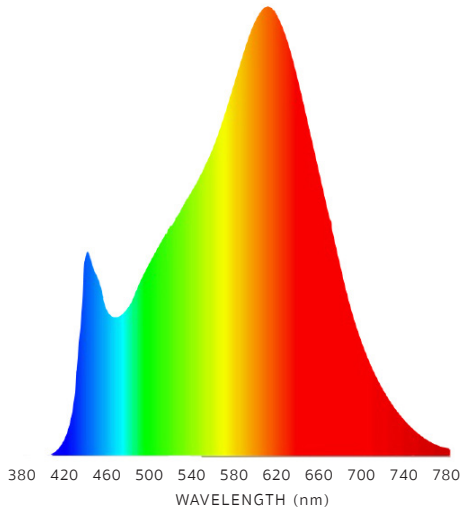

CRI VALUES | R1-R15

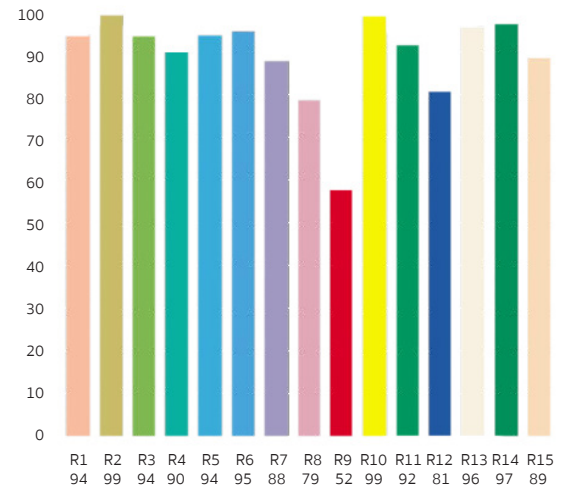

APPLICATIONS

Because of their small size, ability to be enclosed and numerous combinations of options, our MR16 can be used in a variety of applications. Here are a few common ones.

TRACK LIGHTING

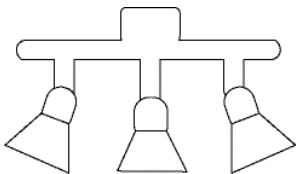

PENDANTS

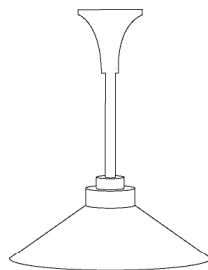

RECESSED LIGHTING

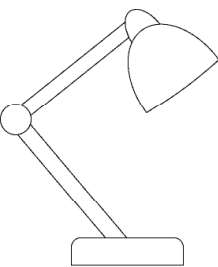
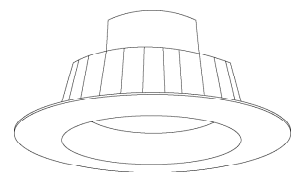

TASK LIGHTING

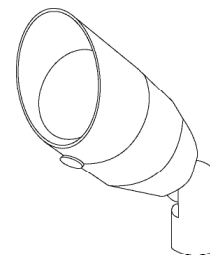

LANDSCAPE LIGHTING