

ASSEMBLY AND INSTALLATION INSTRUCTIONS

H0262

WARNING: TO AVOID RISK OF ELECTRICAL SHOCK, BE SURE TO SHUT OFF POWER WHILE INSTALLING OR SERVICING THIS FIXTURE.

NOTE: 1. Before installing, consult local electrical codes for wiring and grounding requirements.
2. READ AND SAVE THESE INSTRUCTIONS.

Hardware Package(inculded):

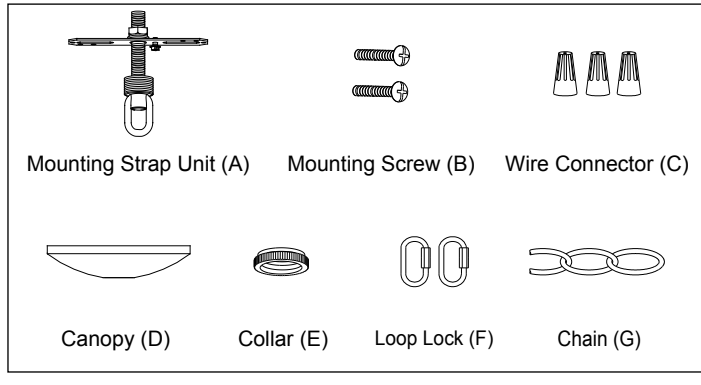

Installation Steps

Turn off the power at fuse or circuit box.

1. Attach the mounting strap unit (A) to the outlet box by using two mounting screws (B).
2. Choose the length of the chain (G) you need, then weave the fixture wire and the fixture ground wire through the chain (G), collar (E) and canopy (D).
3. Connect one end of the chain (G) with the loop by using a loop lock (F).
4. Connect the other end of the chain (G) with the top loop by using another loop lock (F).
5. Thread the fixture wire and fixture ground wire through the top loop, threaded pipe and mounting strap unit (A).
6. Hook the lamp with four tubes and then adjust the angle, finally lock the loop with loop lock (F).

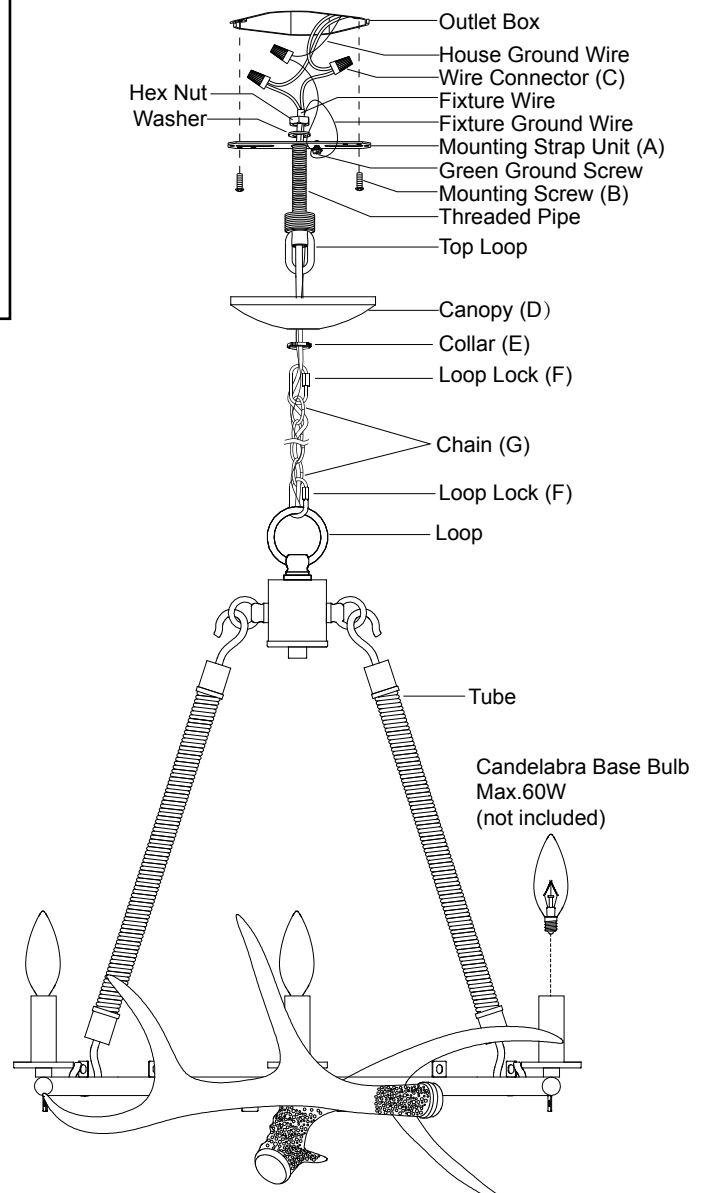





7. Pull out the outlet wires and house ground wire from the outlet box. Make wire connections using the wire connectors (C):
 - The smooth wire (marked) from the fixture to the black wire from the power source.
 - The ridged wire (unmarked) from the fixture to the white wire from the power source.
 - Attach the fixture ground wire to the mounting strap unit (A) with the green ground screw.
 Then connect it to the house ground wire with a wire connector (C). Carefully put the wires back into the outlet box.
8. Attach the canopy (H) to the mounting strap unit (A) by inserting the top loop (I), then secure it with the collar (J).
9. Install four bulbs (not included). See relamping label at socket area or packaging for maximum wattage allowed.

Turn on the power at fuse or circuit box.

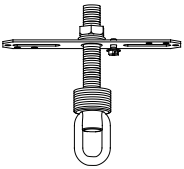
The following parts are available for re-order if damaged or missing.

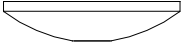
Spare Parts List:

 Mounting Strap Unit (A)	 Mounting Screw (B)	 Wire Connector (C)	Assembly Kit 6333MM (1 SET)
 Canopy (D)	 Collar (E)	 Loop Lock (F)	

