



## PRODUCT FEATURES

- ANSI Designation: M90
- Line Voltage: 120//277
- Regulation: 5%
- Frequency: 60 Hz
- Recommended Fuse (A): 6/3
- Circuit Type: HX-HPF
- Insulation Class: 180°C
- Capacitor Value: 12 MF
- Capacitor Voltage Rating: 280 V
- Capacitor Temperature Rating: 90°C
- Winding Materials: Cu/Cu
- Lamp Starter: N/A
- Agency Certification: RU, cRU
- Maximum Distance to Lamp: 10 FT
- 2 Year Warranty

**LAMP TYPE:** 100W MH

**INPUT VOLTAGE:** Dual (120/277)

**CIRCUIT TYPE:** HX-HPF

## ELECTRICAL SPECIFICATIONS

LINE VOLT (V)	POWER FACTOR	LINE CURRENT			INPUT POWER (W)	OPEN CIRCUIT VOLTAGE (V)	MINIMUM START TEMP	UL TEMP CODE	WIRING DIAGRAM
		OPERATING	OPEN	START					
120	High	1.07	2.63	1.29	122	280	-30°C	A	FC1-1
277	High	0.47	1.13	0.63	122	278	-30°C	A	FC1-1

## WIRING DIAGRAMS

DIAGRAM FC1-1

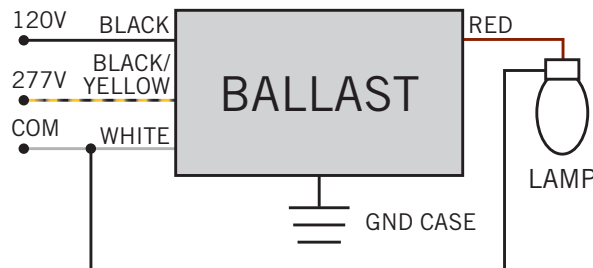



# MH-100X-D-FCAN

100W METAL HALIDE

## CASE STYLE/DIMENSIONS

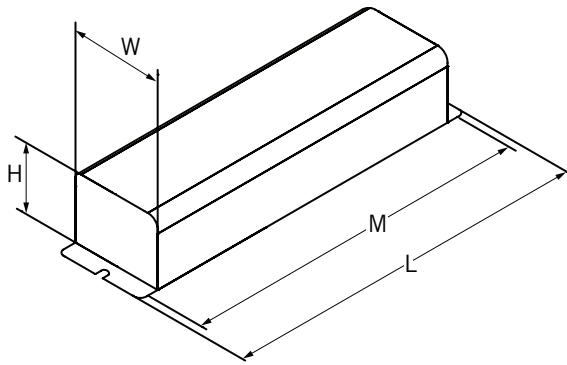

### OVERALL DIMENSIONS

LENGTH: 11.80"
WIDTH: 3.23"
HEIGHT: 2.75"
MOUNTING: 11.40"

**LEAD LENGTH:** 12-14"

**BALLAST NET WEIGHT:** 11.00 lbs

## ORDERING INFORMATION

ORDER CODE	PACKAGING STYLE	PACK QTY.	ITEM STATUS
MH-100X-D-FCAN		1	Quick Ship

## CATALOG NUMBER BREAKDOWN

# MH-100X-D-FCAN

